

Solid State Relay

KSI600 Series Single Phase AC Output



- Zero switching or random-on
- Load current: 10A-100A @ 48-660VAC
- SCR output for heavy industrial loads
- AC or DC input
- DBC substrate for superior thermal performance
- Dielectric strength 4000VACrms
- LED indication
- Internal RC/MOV and TVS protection circuit as option

Product Description

KSI600 series industrial single phase relay with SCR output is the most widely used in industry application. The relay can be used for resistive, inductive and capacitive loads. The control input voltage is 4-32VDC or 90-280VAC, output current rate 10A, 25A, 40A, 60A, 80A, 100A @ 48-660VAC.

Product Selection

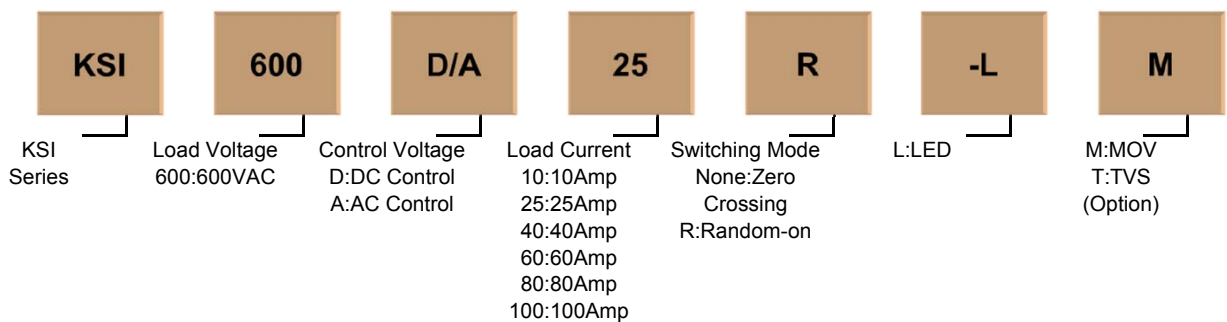

Description	10A	25A	40A	60A	80A	100A
DC:4-32VDC	KSI600D10	KSI600D25	KSI600D40	KSI600D60	KSI600D80	KSI600D100
	KSI600D10R	KSI600D25R	KSI600D40R	KSI600D60R	KSI600D80R	KSI600D100R
AC:90-280VAC	KSI600A10	KSI600A25	KSI600A40	KSI600A60	KSI600A80	KSI600A100

Technical Specification

Input Circuit

Control Voltage Range	DC Input	4-32VDC
	AC Input	90-280VAC
Minimum Turn-On Voltage	DC Input	4VDC
	AC Input	90VAC
Minimum Turn-Off Voltage	DC Input	1VDC
	AC Input	10VAC
Maximum Input Current	DC Input	25mA
	AC Input	10mA

Output Circuit

Load Voltage	48-660VAC
Random-On	1ms

Maximum Turn-On Time	Zero Crossing	1/2AC Cycle + 1ms
	AC Input	20ms
Maximum Turn-Off Time	DC Input	1/2AC Cycle + 1ms
	AC Input	40ms
Maximum Surge Current [@10ms]	10A	150A
	25A	400A
	40A	440A
	60A	860A
	80A	1280A
	100A	1550A
Maximum I ² t For Fusing [@10ms]	10A	350A ² S
	25A	900A ² S
	40A	970A ² S
	60A	3698A ² S
	80A	8192A ² S
100A	12012A ² S	
Transient Overvoltage		1800Vpk
Maximum Off-State Leakage Current [@ Rated Voltage]		5mA
Maximum On-State Voltage Drop [@ Rated Current]		1.6Vrms
Minimum Off-State dv/dt [@ Maximum Rated Voltage]		500V/μs

General Information

Dielectric Strength, Input/Output/Base [50/60Hz]	≥4000Vrms
Ambient Operating Temperature Range	-30°C ~ +80°C
Ambient Storage Temperature Range	-30°C ~ +100°C
Weight [typical]	85g

Application

High-low Temperature Chamber, Plastics Machinery, Incubation Machine, Oiling Machine, HVAC, Elevator, Lighting, Fountain Controller.

Installation

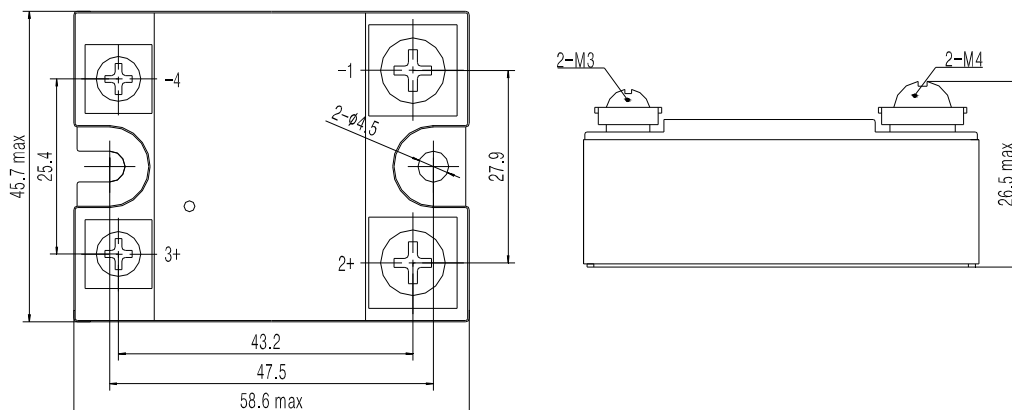

Thermal Curve

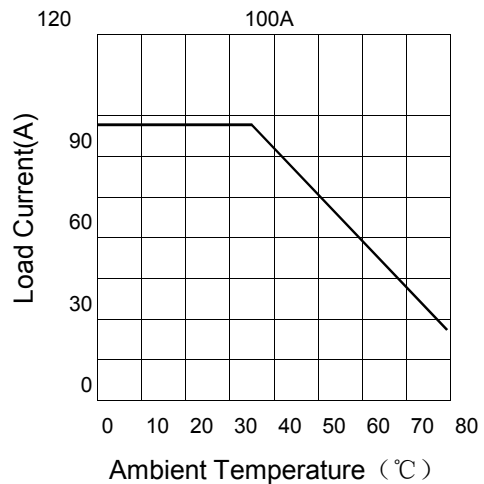
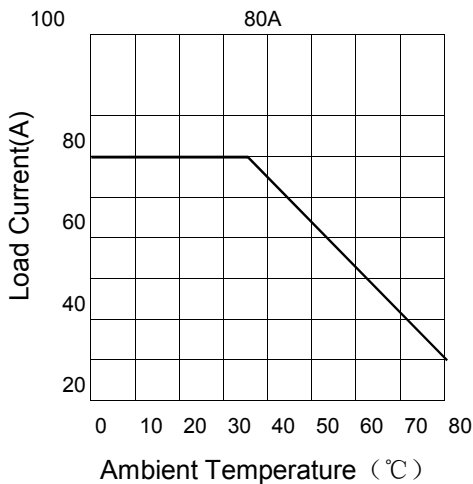
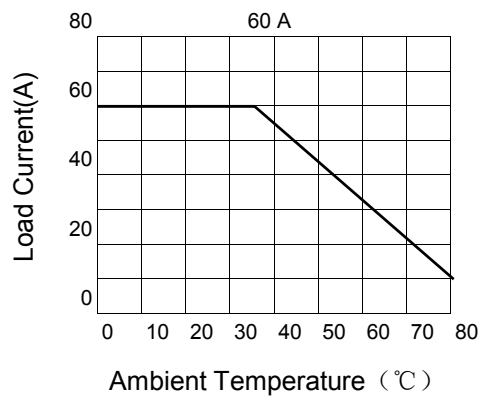
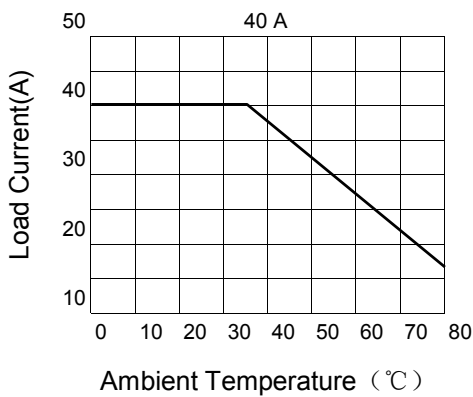
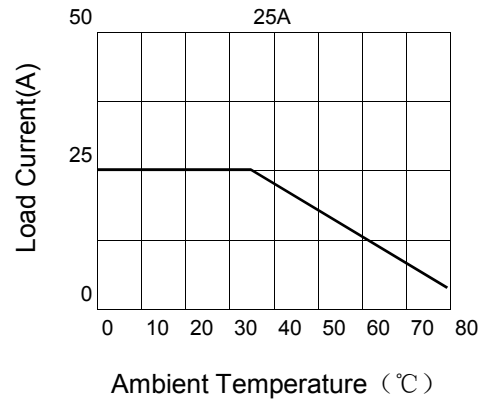
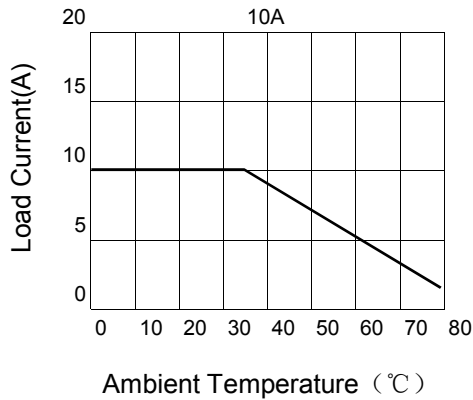

Important Notice

1. When the ambient temperature is over 40°C or many KSI series are installed closely together, the user should take load discount into account according to the thermal curve.
2. If the load current is over 5A, suitable heatsink should be added to the SSR.
3. Plastic cover can be option depends on application to reach IP20.

Product Certification

